









PART NO. 912170, 912171

# ALU BEAM BRACKET

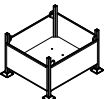
Balkfäste Alu | Bjelkefeste Alu | Sijos kronšteinas Alu | Kiriş braketi Alüminyum | Alu-Träger Klemme

-  L: 130 mm
-  W: 160 mm
-  H: 378/198 mm
-  3,0/2,3 kg
-  Steel + Zn (hot dip galvanized)

-   1,03 × 0,91 × 0,65 m
-  190/270 kg
-  50/100 pcs



#912170

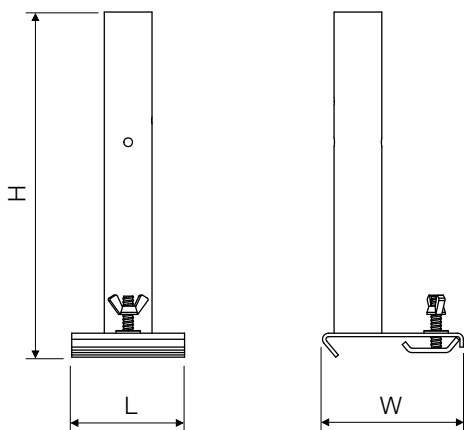

#912171

