











PART NO. 919021

FRAME BARRIER HOLDER

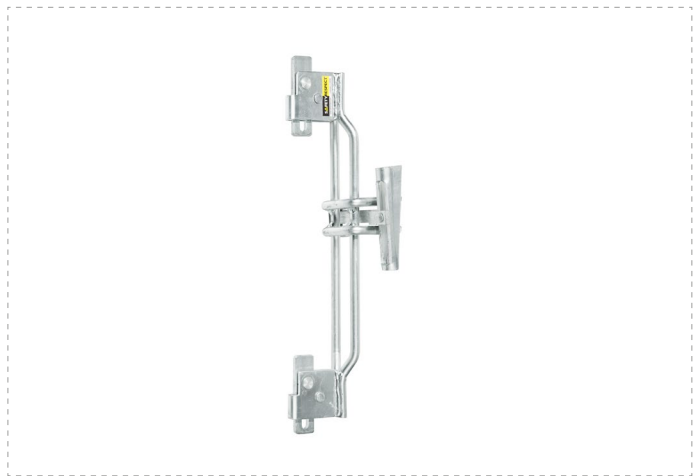
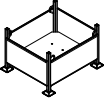
Räckesramhållare | Rekkverksramme holder | Rémininio atitvaro laikiklis | Alüminyum boru kelepçesi | Halterung für Rahmengitter

-  L: 150 mm
-  W: 118 mm
-  H: 481 mm
-  2,1 kg
-  Steel + Zn (hot dip galvanized)
-  EN13374 – A

-  1,03 × 0,91 × 0,65 m
-  215 kg
-  82 pcs

