











PART NO. 911112

PRECAST EDGE HOLDER

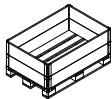
Plattbärlagskantfäste | Kantefeste til plattendekke | Įbetonuojamas kronšteino laikiklis 120 mm | Beton alti soketi | Einbetonierbefestigung | Esivalettu reunapidike

-  L: 235 mm
-  W: 57 mm
-  H: 150 mm
-  0,3 kg
-  Steel
-  EN13374 – A

-  1,20 × 0,80 × 0,73 m
-  1050 kg
-  3000 pcs

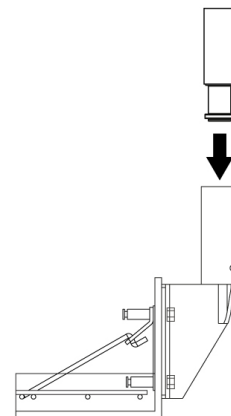
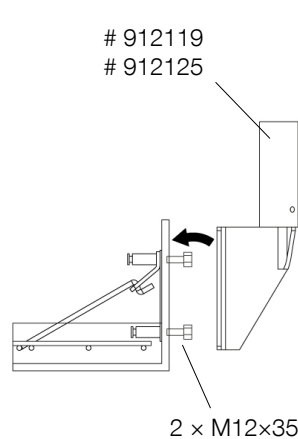
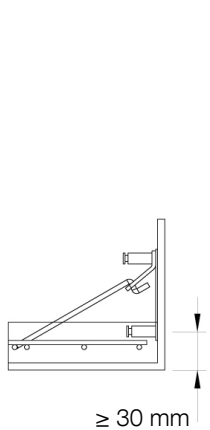
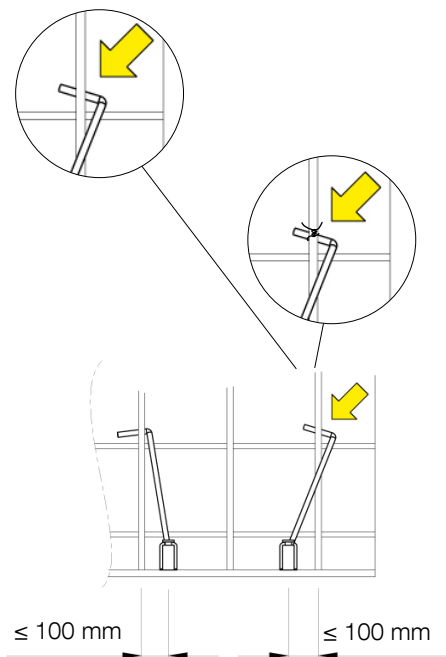
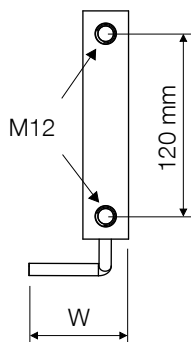
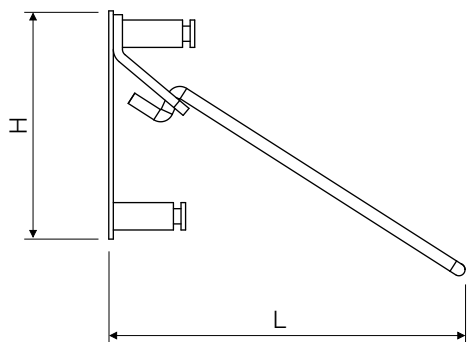

We reserve the right to make technical changes [Apr. 14 2024].