











PART NO. 912117, 912123

# SIDE BRACKET 180

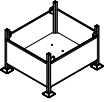
Sidfäste 180 | Sidedefeste 180 | Šoninis laikiklis 180 | Yan braket 180 | Seitenhalterung 180

-  L: 90/98 mm
-  W: 55 mm
-  H: 210 mm
-  0,6 kg
-  Steel + Zn (hot dip galvanized)
-  EN13374 – A

-   1,03 × 0,91 × 0,65 m
-  190 kg
-  250 pcs



# 912117

# 912123

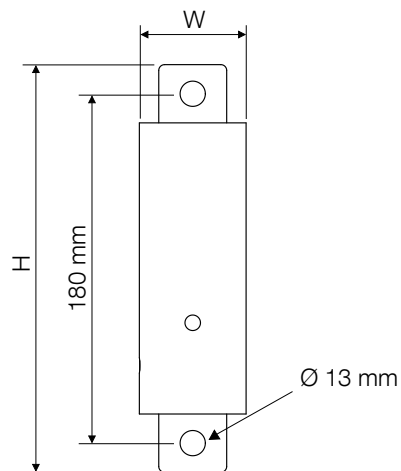
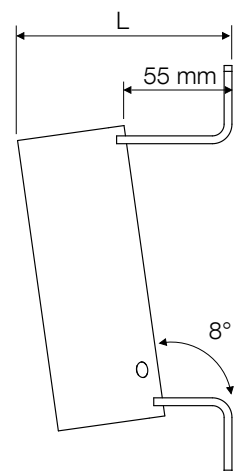
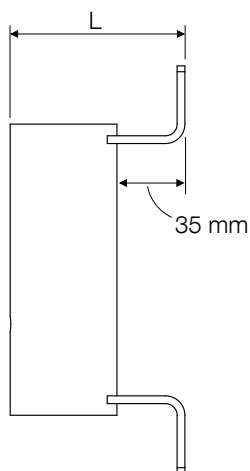

ANCHOR LOADS (Q) <sup>1)</sup> (Per anchor, unfactored)	
N <sub>k</sub>	3,5 kN
V <sub>k</sub>	1,5 kN
<sup>1)</sup> EN 13374:2013 $Q_{k,d} \times \gamma_F^* = E_d \leq R_d = R_k / \gamma_M (k_{mod}^{**})$ * $\gamma_F = 1,5$ ** for timber	

