











PART NO. 5040006

VT EDGE 95, ROUND

VT Edge 95, rund | VT Hoektrapbeugel 95, rond

-  L: 149 mm
-  W: 57 mm
-  H: 238 mm
-  1,4 kg
-  Steel + Zn (hot dip galvanized)
-  EN13374 – A

-   1,24 × 0,84 × 0,97 m
-  440 kg
-  250 pcs

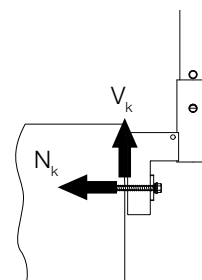
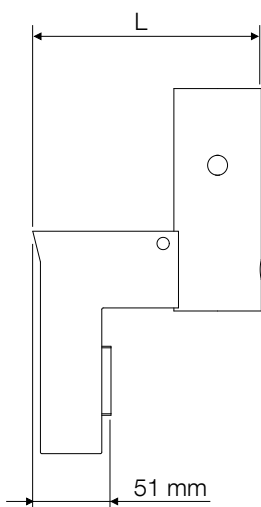
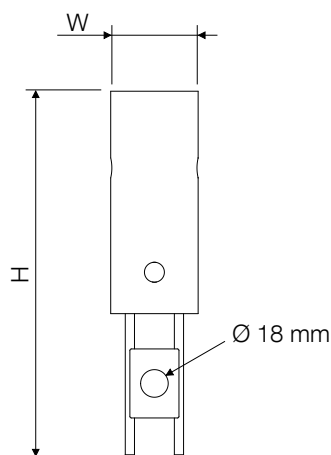

ANCHOR LOADS (Q) ¹⁾ (Unfactored)	
N _k	13,3 kN
V _k	1,5 kN

¹⁾ EN 13374:2013
 $Q_{d1} \times \gamma_F^* = E_d \leq R_d = R_k / \gamma_M (k_{mod}^{**})$
^{*} $\gamma_F = 1,5$ ^{**} for timber

