











PART NO. 5040002

VT FOOT, ROUND

VT Fuß, rund | VT Voetplaat, rond

-  L: 200 mm
-  W: 125 mm
-  H: 110 mm
-  1,5 kg
-  Steel + Zn (hot dip galvanized)
-  EN13374 – A

-   1,24 × 0,84 × 0,97 m
-  690 kg
-  400 pcs

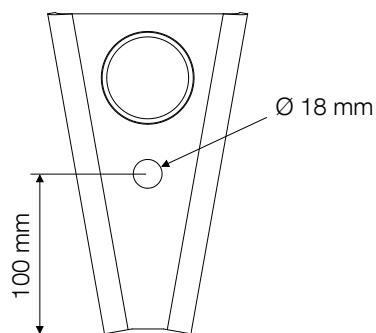
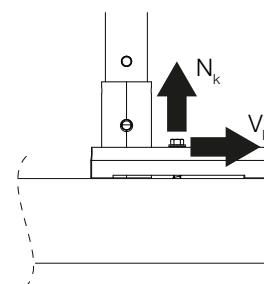
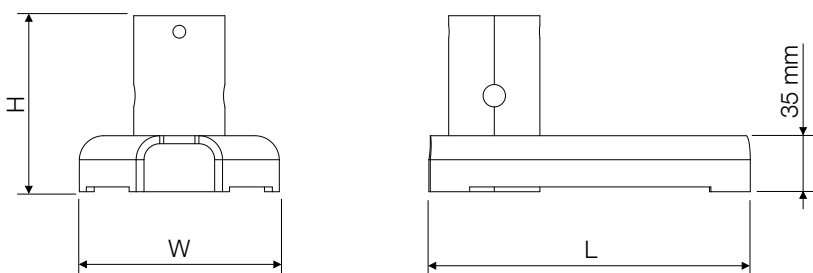

ANCHOR LOADS (Q) ¹ (Unfactored)	
N _k	5,4 kN
V _k	0,8 kN

¹⁾ EN 13374:2013
 $Q_{k,i} \times \gamma_F^* = E_d \leq R_d = R_k / \gamma_M (k_{mod}^{**})$
^{*} $\gamma_F = 1,5$ ^{**} for timber

