











PART NO. 912121

WALL BRACKET

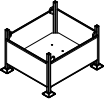
Väggfäste | Veggfeste | Tvirtinimo prie sienos detale | Duvar braketi | Wandhalterung

-  L: 75 mm
-  W: 50 mm
-  H: 150 mm
-  0,7 kg
-  Steel + Zn (hot dip galvanized)
-  EN13374 – A

-   1,03 × 0,91 × 0,65 m
-  390 kg
-  500 pcs

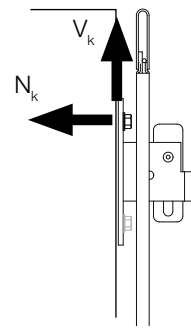
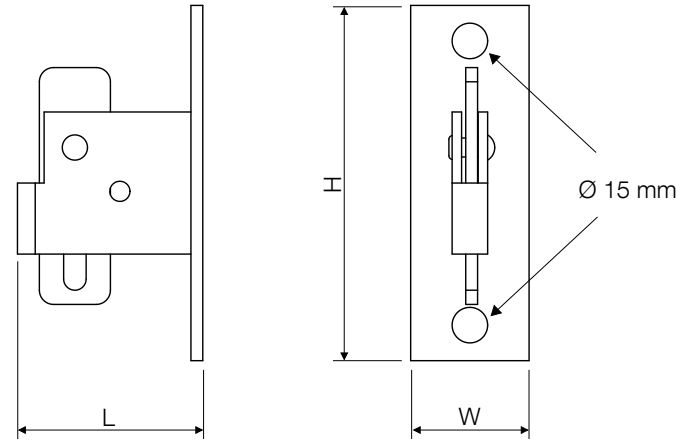

ANCHOR LOADS (Q) ¹ (Unfactored)	
N _k	0,8 kN
V _k	1,5 kN

¹) EN 13374:2013
 $Q_{k,i} \times \gamma_F^* = E_d \leq R_d = R_k / \gamma_M (k_{mod}^{**})$
^{*} $\gamma_F = 1,5$ ^{**} for timber

